

PRIVACY FENCE & GATE INSTALLATION INSTRUCTIONS



Outdoor Solutions Company, Inc.

24 Young Road Katonah, New York 10536

sales@VinylFence.com

Toll Free: 888-348-4695 Toll Free Fax: 877-889-1639

BEFORE YOU START, IT'S IMPORTANT TO CHECK . . .

- . . . That fence footings do not exceed legally established property lines. If uncertain, refer to real estate agent's line plot or consult a professional surveyor.
- . . . Local codes for specifications regarding frontage locations, allowable fence heights, etc. A permit may be required.
- . . . With local utility companies for locations of underground cables or pipelines.

PRIVACY PANEL

PARTS LIST

EACH 5' & 6' HIGH PRIVACY PANEL INCLUDES:

- A.** 1-1/2" X 5-1/2" Routed Rails (2)
 - B.** 7/8" X 6" Tongue and Groove Pickets (15)
 - C.** 7/8" PVC U-Channel (2)
 - D.** Galvanized Steel Insert (1)
- #8 X 3/4" Stainless Steel Screws (6) – Not shown
1.5 Oz. Tube PVC Glue (1) – Not shown

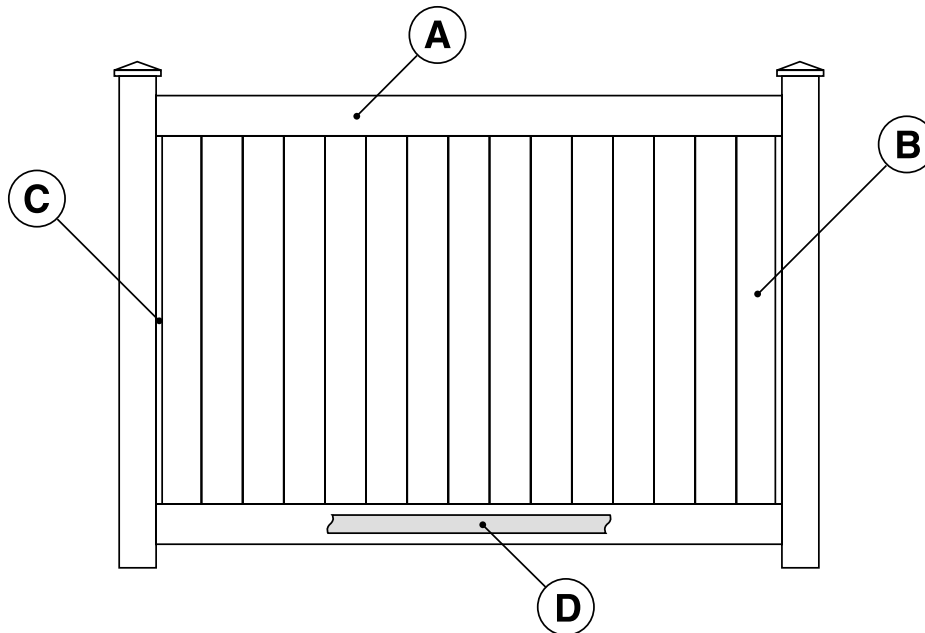

NOTE: Standard fence sections and gates are designed for level terrain. Significant slopes in the terrain will necessitate modifications to panel kits, gate kits and posts.

GENERAL INFORMATION:

Read this instruction sheet completely before starting work.

During panel/gate assembly, work on a soft, non-abrasive surface to avoid scratching the PVC. When cutting PVC components with a power saw, use a fine-toothed blade (plywood blade, finishing blade, etc.).

Plan ahead when working with PVC glue. It dries very fast, requiring speed and precision.

Laying out the fence is the critical first step toward ensuring a quality installation.

STEP 1

Locate the boundary lines to your property.

STEP 2

Drive stakes into the ground along the property line and stretch a string between each stake. **Be sure to extend the string about 24" beyond the property line (Fig. 1).**

It is recommended that all posts be set approximately 6" inside of the property line so that concrete footings do not encroach onto the adjoining property.

STEP 3

Mark the location of each terminal post with a stake (corner, end and gate posts are called **terminal** posts).

When determining the position of the gate posts, refer to Privacy Gate section for actual gate opening.

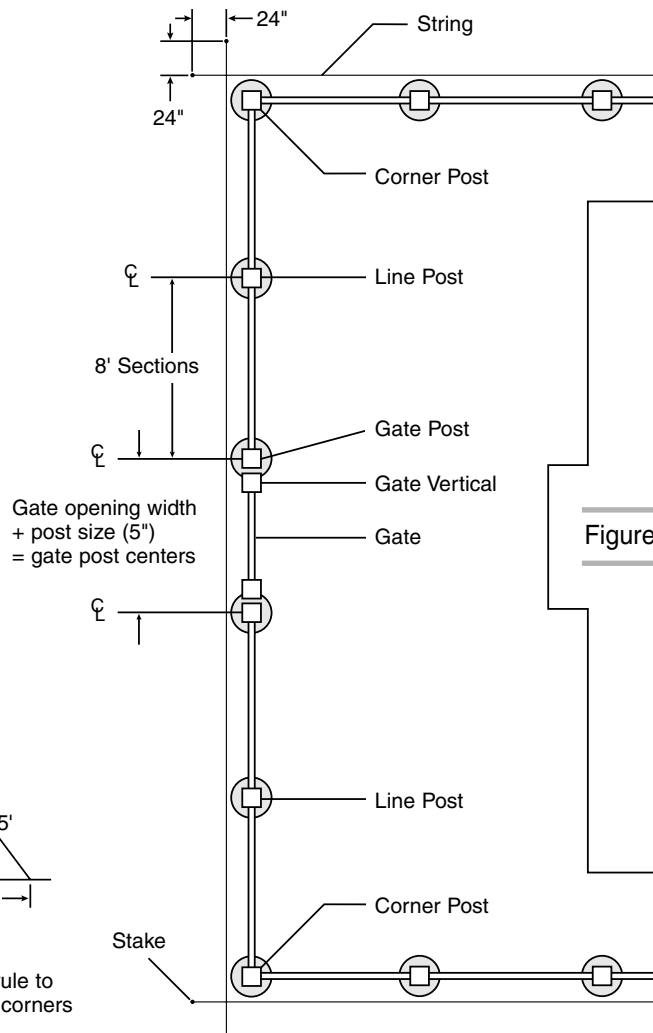
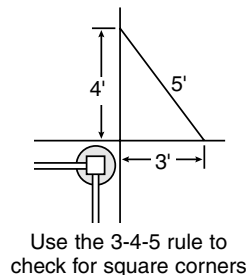

Although post depth and hole diameter will be determined by local weather and soil conditions, holes for terminal posts and line posts are typically dug 10" in diameter and 30" deep with sloped sides (Fig. 2).

STEP 1

Dig all terminal post holes.

SET ALL TERMINAL POSTS IN CONCRETE.

STEP 2

Position the post in the hole. The posts should be centered in the hole and must be square with the fence line so that when the rails are inserted into the posts they will parallel the string line. Check the post on two adjacent sides with a carpenter's level and adjust as necessary to make sure it is plumb. The fence height above grade is determined at this time as well. We recommend 2" be left from the bottom of the bottom rail to the ground.

STEP 3

Pour concrete around post, fill to 2" below ground level. Once the concrete is completely dry, fill the balance of the hole with dirt.

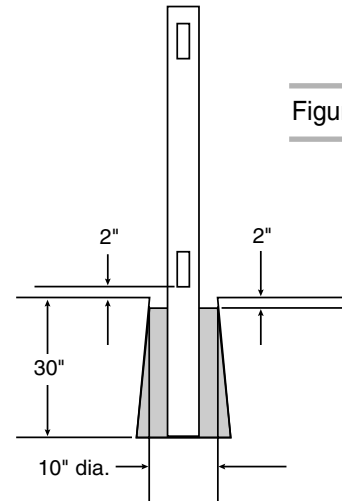

Figure 2

STEP 1

After the terminal post footings have hardened enough for the posts to remain stable, stake and stretch a string line taut across the tops of the posts to mark the desired height of the line posts (Fig. 3).

STEP 2

Working along the string line, stake out the positions of all line posts.

STEP 3

Dig all line post holes.

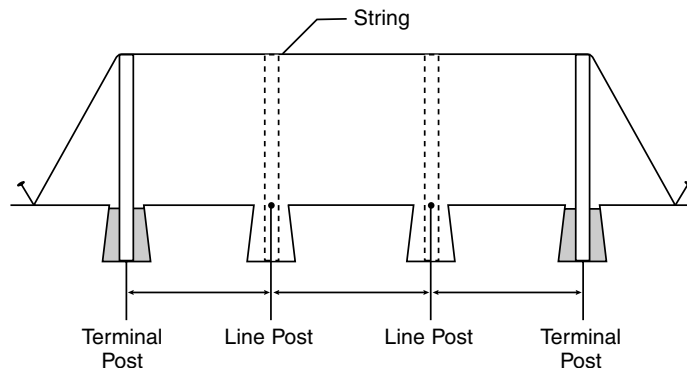

Figure 3

STEP 1

If post spacing is less than 8' on center, cut a piece from the end of the top and bottom rails to achieve the desired length.

The length of the top and bottom rails should be 1/2" less than the center-to-center measurement of the posts.

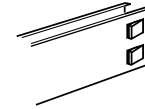

Figure 4

STEP 2

Using the Legend notching tool, notch both ends of the bottom rail with one or two notches on each side (Fig. 4). Hold the rail and the tool steady while notching, avoid twisting the tool.

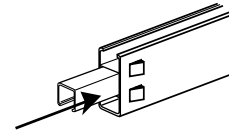

Figure 5

STEP 3

Starting at a terminal post, slide the metal insert into the bottom rail (Fig. 5). If the rail is going into a post that will be filled with concrete (refer to section 6, 'FILLING POST WITH RE-BAR & CONCRETE'), seal the end of the rail with duct tape to prevent concrete from flowing into it (Fig. 6).

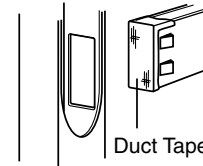

Figure 6

STEP 4

Slide the rail into the bottom hole in the post (Fig. 7).

Proceeding down the fence line, place the next post into the next hole and insert the bottom rail into the post.

Figure 7

STEP 5

Fill the post hole with concrete.

Check to make sure that the post is set at the correct height, is plumb and level and square to the fence line. Block and support as necessary to keep the posts stable as installation continues.

Repeat these steps until all posts are set with the bottom rails and inserts installed.

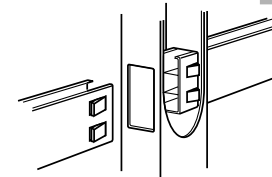
**STEP 1**

Center the U-channels on the post, between the bottom rail and the hole for the top rail with the flat side of the channels against the posts (you can insert an un-notched top rail to serve as a guide, if necessary).

Drill pilot holes and secure the channels to the posts using the #8 x 3/4" stainless steel screws supplied (Fig. 8).

STEP 2

Notch all remaining rails.

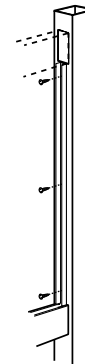

Figure 8

STEP 3

If post spacing is less than 8' on center, you may need to cut equal amounts off of the grooved side of the picket on one end of the panel and the tongued side of the picket on the opposite end (Fig. 9).

STEP 4

Starting on one end, insert the first picket into the bottom rail and the U-channel (if you have cut the first picket, the cut end should go into the channel). Proceeding down the panel, insert pickets into the bottom rail, interlocking the tongues and grooves as you go. When you get toward the end of the panel, begin working from the opposite post back toward center (keep tongues and grooves oriented in the same direction), so that the last picket to be inserted is 3 to 4 pickets in from the post. Slide the last picket in from the top (Fig. 10).

STEP 5

If the rail is going into a post which will be filled with concrete (refer to section 6, 'FILLING POSTS WITH RE-BAR & CONCRETE'), seal the ends of the rail with duct tape to prevent concrete from flowing into it (refer to section 4, 'SETTING LINE POSTS AND RAILS', step 4). Place one end of the top rail into the post and work your way down the panel, inserting pickets into the top rail as you go (Fig. 11).

STEP 6

Once all of the pickets are installed, slide the loose rail end into the post (Fig. 12).

Repeat these steps until all panels have been assembled.

Figure 9

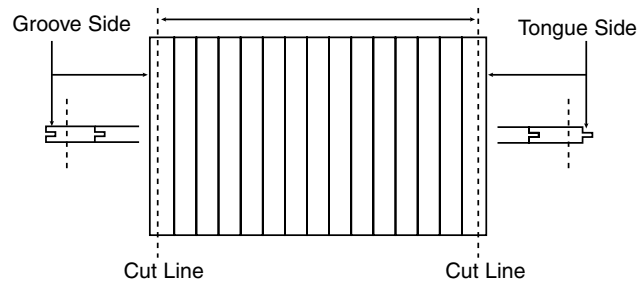

Figure 10

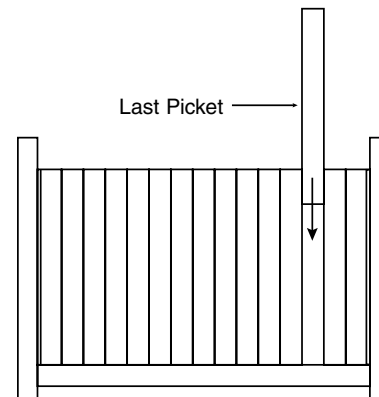

Figure 11

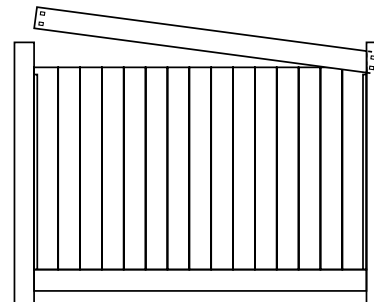
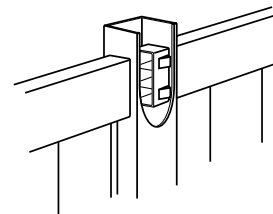

Figure 12



Gate posts*, corner posts and end posts should be filled to within 2" of the top of the post with concrete and re-bar. Line posts should be filled half-way with concrete only.

* Make sure the gate hardware is installed before filling gate posts with concrete.

STEP 1

NOTE: *If re-bar is not being used, proceed to step 2.*

For each end and gate post cut two pieces of #4 re-bar 4" shorter than the post length. Drop two pieces into each post at opposing corners (Fig. 13).

STEP 2

Using a large funnel, fill the posts with concrete (Fig. 14). Tap lightly on the sides of the post to help void air pockets in the concrete.

STEP 3

Clean up excess concrete with water before it dries.

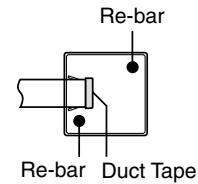

Figure 13

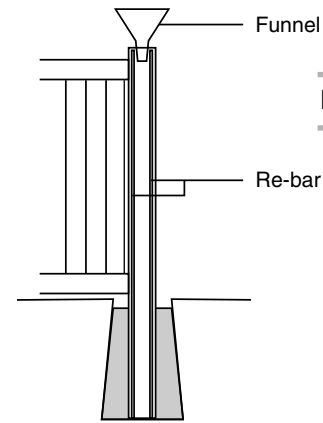

Figure 14

Note: Do not install post caps on gate posts until gate installation is complete.

EXTERNAL CAPS (*slide over the post*)

STEP 1 (Option A)

Apply PVC glue to the inside of the cap and press completely onto the top of the post (Fig. 15). Press firmly to ensure that the cap is on as far as it will go.

INTERNAL CAPS (*slide into the post*)

STEP 1 (Option B)

Apply PVC glue to the inside of the post and slide the cap completely inside (Fig. 16). Press firmly to ensure that the cap is on as far as it will go.

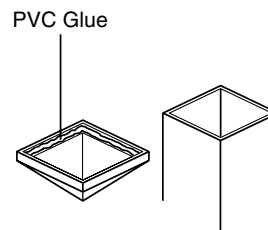

Figure 15

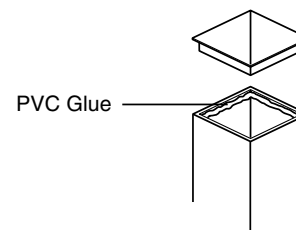

Figure 16

PRIVACY GATE

PARTS LIST

Available in 5' and 6' heights. Gate openings are 37-1/2", 49-1/2" and 61-1/2".

EACH PRIVACY GATE INCLUDES:

- A. 1-1/2" X 5-1/2" Routed Rails (2)
- B. 5" Sq. Gate Verticals w/Pockets (2)
- C. 5" Sq. Pyramid Caps (2)
- D. 7/8" X 6" Tongue and Groove Pickets (*)
- E. Heavy Duty Hinges (2)
- F. Heavy Duty Latch (1)
- G. 7/8" X 1-1/2" Diagonal Brace (1) (4' & 5' wide)
Wood Insert for Diagonal Brace (1) (4' & 5' wide)
- H. #8 X 1-1/2" Stainless Steel Screws (*) (4' & 5' wide)
Screw Cap Washers (*) (4' & 5' wide)
Screw Caps (*) (4' & 5' wide)
- I. 7/8" U-Channels (2)
#8 X 3/4" Stainless Steel Screws (6) – Not shown
1.5 Oz. Tube PVC Glue (1) – Not shown

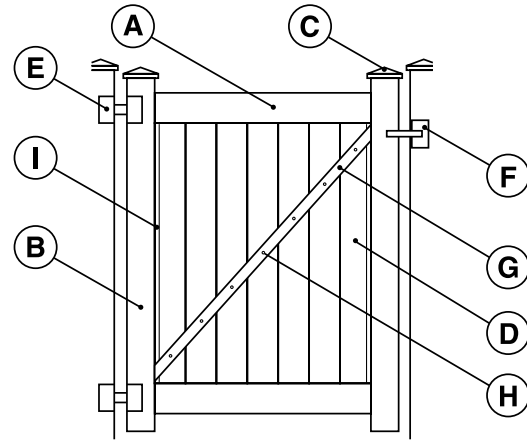

*3' wide = 4, 4' wide = 6, 5' wide = 8

1

DETERMINE GATE WIDTH

Standard 3', 4' & 5' wide gates are made to fit openings measuring 37-1/2", 49-1/2" & 61-1/2" respectively, between the posts. The actual gate width will be 3" less than the opening between posts (Fig. 17).

If your gate opening is narrower than standard, use the following information to modify your gate kit:

STEP 1

Cut the horizontal rails 5-1/2" shorter than the opening width between the posts (Fig. 18).

If you need to cut pickets to accommodate narrower gate width, do so as detailed in Privacy Panel section 5 'INSTALLING PICKETS', Step 3.

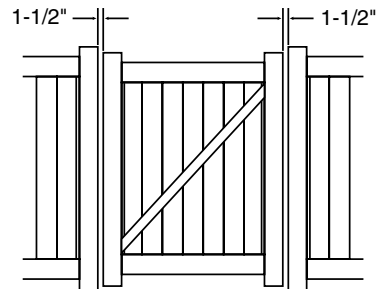

Figure 17

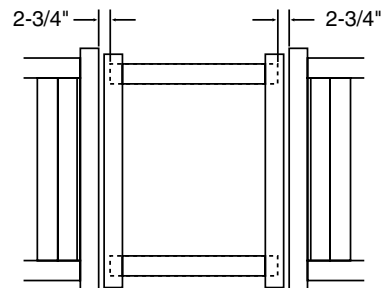

Figure 18

NOTE: The gate verticals are not universal, they have a top and a bottom. The top gate pocket is 3" from the top end of the gate vertical.

STEP 1

Insert the rails into the gate pockets - do not glue at this time.

STEP 2

Position U-channels between the rails, with the flat side of the channels against the gate verticals. Drill pilot holes and secure the channels to the gate verticals using the #8 x 3/4" stainless steel screws supplied (Fig. 19).

STEP 3

Remove the rails from the gate pockets.

STEP 4

Working on one side of the gate, apply PVC glue liberally to the inside of the gate pockets and quickly slide the rails completely into the pockets.

STEP 5

Slide pickets into the rails from the open end, being sure to interlock the tongued and grooved joints completely.

STEP 6

Apply PVC glue liberally to the inside of the gate pockets on the second gate vertical and quickly slide the gate vertical completely onto the rails, making sure that the last picket sits inside of the U-channel (Fig. 20).

STEP 7

Check to make sure that the gate is square (the distance between opposite corners should be equal) (Fig. 21).

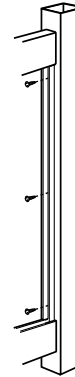

Figure 19

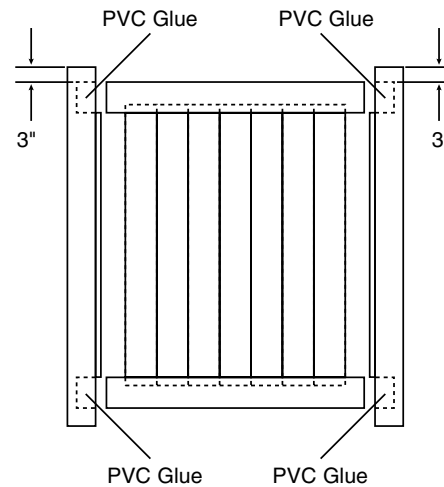

Figure 20

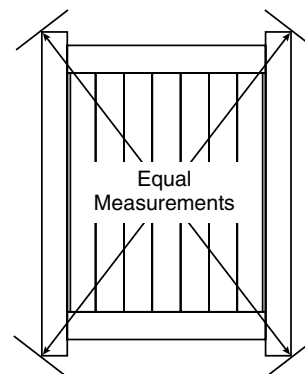

Figure 21

STEP 1

Position the diagonal brace (on 4' and 5' wide gates only) on the back side of the gate, between the rails and against the backs of the pickets. The gate brace should attach to the gate vertical at the top rail on the latching side of the gate and at the bottom rail on the hinging side of the gate (Fig. 22).

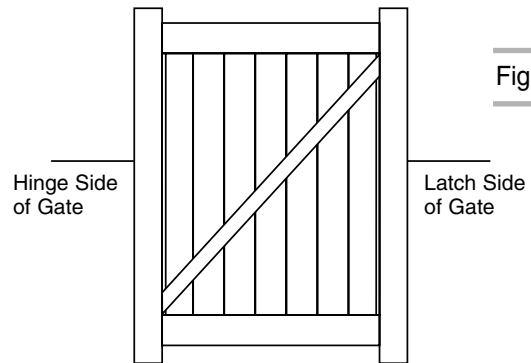

Figure 22

STEP 2

If the gate has been modified, mark the correct length and angle and cut the brace. Cut the wood insert to match and slide the wood insert into the diagonal brace (Fig. 23).

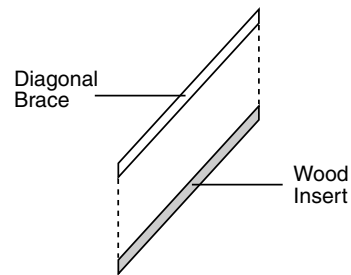

Figure 23

STEP 3

Hold the brace in position and carefully drill through the brace, wood insert and the back wall of the pickets (Fig. 24).

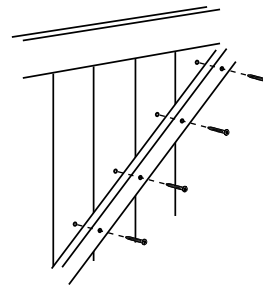

Figure 24

STEP 4

Secure the brace with #8 X 1-1/2" screws, screw cap washers and screw caps (Fig. 25).

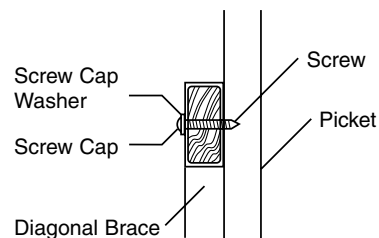

Figure 25

4**INSTALLING GATE VERTICAL CAPS****STEP 1**

Install the caps on the gate vertical as described in the Privacy Panel section 7 'INSTALLING POST CAPS'.

5**HANGING THE GATE****STEP 1**

Position the gate in the gate opening and block-up the gate as necessary to line up the horizontal gate rails with those of the fence (Fig. 26). Attach hinges and latch to the gate and posts per the installation instructions packaged with the hardware.

STEP 2

Fill gate posts with concrete and re-bar as described in Privacy Panel section 6, 'FILLING POSTS WITH RE-BAR & CONCRETE'.

STEP 3

Install gate post caps (refer to Privacy Panel section 7, 'INSTALLING POST CAPS').

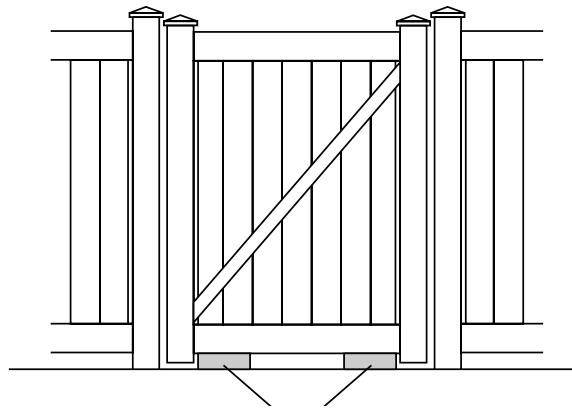

Figure 26

6**CLEAN-UP**

Clean PVC material as necessary with a non-abrasive (or slightly abrasive) mild biodegradable soap and soft plastic scouring pad. Rinse thoroughly with clean water to remove dirt and soap.